

Effective video streaming using Mesh P2P with MDC over MANETs

N.Qadri¹, A. Liotta², M.Altaf¹, M. Fleury¹, M. Ghanbari¹

¹University of Essex, Colchester, United Kingdom

e-mail {nnawaz, maltaf, fleum, ghan}@essex.ac.uk

²Eindhoven University of Technology, Netherlands

e-mail: a.liotta@tue.nl

Abstract

Peer-to-Peer (P2P) streaming and Mobile Ad hoc Networks (MANETs) have turned out to be two of the most active research areas for pervasive computing. These areas were developed independently of each other with the result that there is insufficient verification of whether the P2P distribution paradigm and specifically P2P real-time video streaming would work on MANETs. In this paper, we demonstrate that mesh-based P2P streaming together with Multiple Description Coding (MDC) over MANETs effectively provides real-time video streaming. MDC, a promising video coding technique, is emerging as an alternative way to improve video quality for both P2P over an internet and for MANET applications. This paper shows that mesh-based P2P when combined with MDC results in improvement in delivered video quality making it acceptable for ad hoc networks. For that purpose, the GloMoSim simulator was modified to support mesh-based P2P and MDC. Real-time video streaming will be useful for many ad hoc applications such as search and rescue applications, military applications, inter-vehicular communication, and video conferencing.

1. Introduction

Peer-to-Peer (P2P) systems and Mobile Ad-hoc Networks (MANETs) have been developed by different communities in order to address entirely different requirements. P2P networks are application-oriented overlays, which enable a range of P2P applications such as P2P file sharing and more recently P2P streaming. So far P2P overlay networks have evolved mainly over the wired Internet [1]. In contrast, MANETs are spontaneous, infrastructure-less networks whose elements are normally (mobile) user terminals. In MANETs, different nodes federate themselves to provide end-to-end, ‘on-the-fly’ connectivity, which hopefully can be at anytime and anywhere. Despite being fundamentally different, MANETs and P2P networks share the common vision of load distribution that is based on a user’s willingness to share resources [2]. For this purpose, our previous article [3] reported simulation-based initial findings that mesh-based P2P (mesh-P2P) is acceptable in some scenarios but fails to perform in others. This paper shows that mesh-P2P when combined with Multiple Description Coding (MDC), a form of advanced video compression coding in support of error resilient video streaming, results in improvement in delivered video quality, making it acceptable for ad hoc networks.

MANETs [4] introduce a new communication paradigm that does not require a fixed infrastructure — instead they rely on wireless terminals for routing and transport services. It is a challenging task to transport real-time video over ad hoc networks, owing to their dynamic topology, the absence of an established infrastructure for centralized administration, the presence of bandwidth-constrained

wireless links, and the limited processing and power capabilities of mobile terminals within the ad hoc network.

Recently, several decentralized P2P streaming systems such as mesh-P2P streaming [5] have been deployed to provide live and on-demand video streaming services on the Internet and the same ideas may be useful in providing real-time video streaming in ad hoc networks. Both MANETs and P2P networks are decentralized, autonomous and highly dynamic in a fairly similar way. In both cases, network nodes contribute to the overall system performance in an intermittent and unpredictably manner but nonetheless exhibit a high level of resilience and availability. Fig. 1 illustrates a P2P application overlay over a MANET, in which an overlay network is placed over the network layer. The overlay node placement is logically different to that of the physical placement of the nodes.

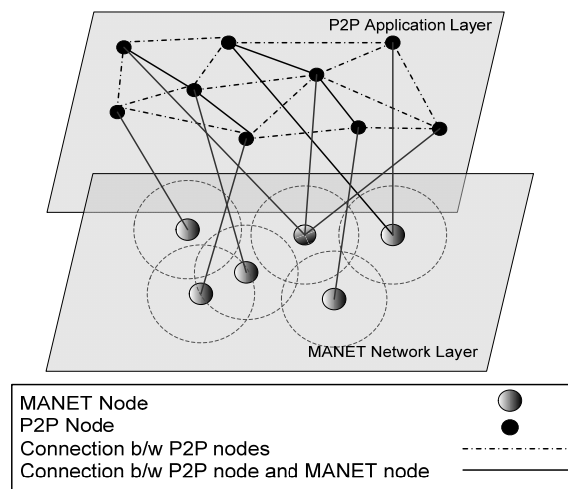

Figure 1. An example of P2P application overlay over MANET, after [6]

For many P2P streaming applications particularly within a mesh-P2P-type architecture, MDC is proving to be a better solution than unicast streaming, and is also a scalable video coding technique [7-10]. MDC has emerged as an alternative way to improve the performance of streaming video in both P2P streaming [8] and over ad hoc networks [9]. MDC [11] splits video streams into two or more versions or descriptions that are sent over multiple paths. Each description can serve to reconstruct the video but if more than one description is received the quality can be enhanced by combining the descriptions. MDC differs from layered video coding because in the latter the base layer must be received in order to reconstruct the video for display. Therefore, MDC has become a popular technique for real-time applications as it provides graceful video quality degradation without the need for retransmission. If packet loss or delay occurs on one of the paths then this can be compensated for by the encoded bit stream from other paths. MDC also may reduce the bandwidth requirement [12] for any one route through an ad hoc network, at a cost in increased coding redundancy. In this work, we make the common assumption for simplicity that there are just two streams. In fact, simplified versions of MDC are simulated, as in practical schemes the complexity of an MDC decoder, which needs to reconcile several streams as well as avoid encoder-decoder drift could overwhelm the processing capability of a mobile node.

Real-time video communication of video will significantly aid in many ad hoc applications such as during civil or military emergencies. Providing real-time video streaming for search and rescue

applications will help rescue teams to get a clearer picture of a disaster area than through text messages or still images. In these situations, a video clip will probably originate from a single source but then be distributed to other peers, whereupon the video can be streamed through the P2P overlay network. Because of the display resolution and processing power of hand-held or wearable devices used in these applications the Quarter Common Intermediate Format (QCIF) 176×144 pixel resolution at a maximum of 30 frame/s (fps) and possibly as low as 10 fps is likely [13]. This is convenient as supportable data rates across multi-hop paths could be low. However, encoded video streams are fragile as temporal redundancy is removed through the processes of motion estimation and compensation [14]. Because loss of packets from a reference frame within the 12 or 15 frames of a Group of Pictures¹ (GOP) has an effect that endures to the end of the GOP, the packet loss ratio is important. If video communication were to be two-way or interactive then mean delay is also important.

The contribution of this paper is to evaluate the performance of mesh-based P2P combined with MDC and compare it with simple mesh-P2P streaming over MANET. We believe that a combination of MDC and P2P streaming over MANET would be an effective solution to provide real-time video streaming for ad hoc applications. Little prior research has apparently considered the possibility of running P2P streaming applications across a MANET, though P2P file download has been actively investigated, as will be apparent from the survey in [2] which mentions eight contributions to file sharing across ad hoc networks. However, streaming applications have additional latency constraints. P2P overlay networks allow physical networks to better cope with the higher bitrates required for video streaming by increasing the number of peers and [15] investigated ways of facilitating peer selection to optimise throughput across a MANET. To do so, congestion information across the underlay network (the physical network underlying the P2P overlay network) was utilised to assign rates between peers. Network-wide optimisation of throughput was achieved through the method of Lagrange multipliers. However, there was no investigation of node speed and limited investigation of the effect of network size and distribution protocol. In contrast, a naturally-inspired peer search algorithm, based on the behaviour of ant colonies, was investigated in [16]. A simulation with 1600 nodes supported the idea, though clearly this work was at a preliminary stage in the investigation. It should also be mentioned that unless in a stadium or other crowded venue it is unlikely that there will be so many nodes available. Similarly, in [17] a hierarchical arrangement of MANETs was introduced to reduce distribution latency. P2P streaming was given a practical investigation in [18], when vehicles were driven around a building in a university campus to check the feasibility of video streaming. The main finding was that provided the number of hops was limited then streaming was possible across a vehicular network. Like other work in this field, research in [18] is at an exploratory stage but it is certainly likely that there will be many cars able to act as peers.

The rest of the paper is organized as follows. Section 2, gives an overview of mesh-P2P streaming technique highlighting its merits and demerits. Section 3, discusses MDC schemes. Section 4 introduces the simulation environment and evaluation metrics. Simulation results and analysis are presented in Section 5, while Section 6 concludes the paper.

2. P2P streaming

¹ The distinction between picture and frame is only relevant for interlaced video and the terms are inter-changeable when progressive video is considered.

The P2P streaming concept has nowadays been developed into several trial P2P streaming systems, such as Joost, Sopcast, Zattoo, and PPlive [19]. The online broadcasting arena is evolving in response to the clear commercial interest for these new technologies in support of IPTV (TV over IP-framed networks). P2P streaming architectures can be categorized according to their distribution mechanisms. The various approaches to P2P streaming have been surveyed by Liu et al.[20]. Two main topologies have emerged, i.e. tree-based and mesh-based P2P. Our implementation is particularly concerned with mesh-P2P. This is because in a MANET the network topology changes randomly and unpredictably over time. Hence, an application that can easily adapt to the dynamic behavior of the ad hoc network will be an effective solution. Mesh-P2P streaming is flexible and can be managed easily in comparison to a tree-based topology. Moreover, it is not affected by the churn of peers or the effects of handover. A mesh-based topology can also overcome the bandwidth heterogeneity present in a MANET. Consequently, we believe that it is an effective solution for a MANET. Finally, mesh-based distribution is becoming more widespread than tree-based distribution and has been adopted by most successful P2P streaming systems[21-23]

2.1 Mesh-P2P distribution

The very successful BitTorrent P2P file distribution protocol [24] has been the inspiration behind mesh-P2P streaming. In the all-to-all connectivity of a mesh, the overlay network supporting the stream distribution incorporates the swarm-like content delivery introduced by BitTorrent.

To deliver a video stream, the video is divided into chunks or blocks in such a way that allows a peer to receive portions of the stream from different peers and assemble them locally, leading to the delivery of good quality streams to a large number of users. The original video stream from a source is distributed among different peers [25]. A peer joining a mesh retrieves video chunks from one or more source peers. The peer also receives information about the other receiver peers from the same sources that serve the video chunks. Each peer periodically reports its newly available video chunks to all its neighbours. The chunks requested by each peer from a neighbour are determined by a packet scheduling algorithm based on available content and bandwidth from its neighbours [25]. This approach is more robust than the tree-based architecture, since when a stream comes from various sources communication does not break when only a subset of peers disconnect. The packet scheduling algorithm and peer selection or querying mechanism is beyond the scope of our paper and we assume that it has been achieved. We also assume that in MDC streaming the same blocks (but not necessarily the whole video) are held by two or more nodes and are streamed to a single destination node in the P2P overlay network.

In this paper, we have simulated a mesh-P2P-type architecture, as shown in Figure 2. We have used seven nodes to form a mesh out of which two nodes are source nodes i.e. peer A and peer B each have an independent video description. Three nodes (peer C, peer D and peer E) join with these source nodes to retrieve the video content. These three nodes then connect to two further nodes (peer F and peer G) to serve the video contents that they are receiving from peers A and B. Here, nodes C, D and E download and upload at the same time.

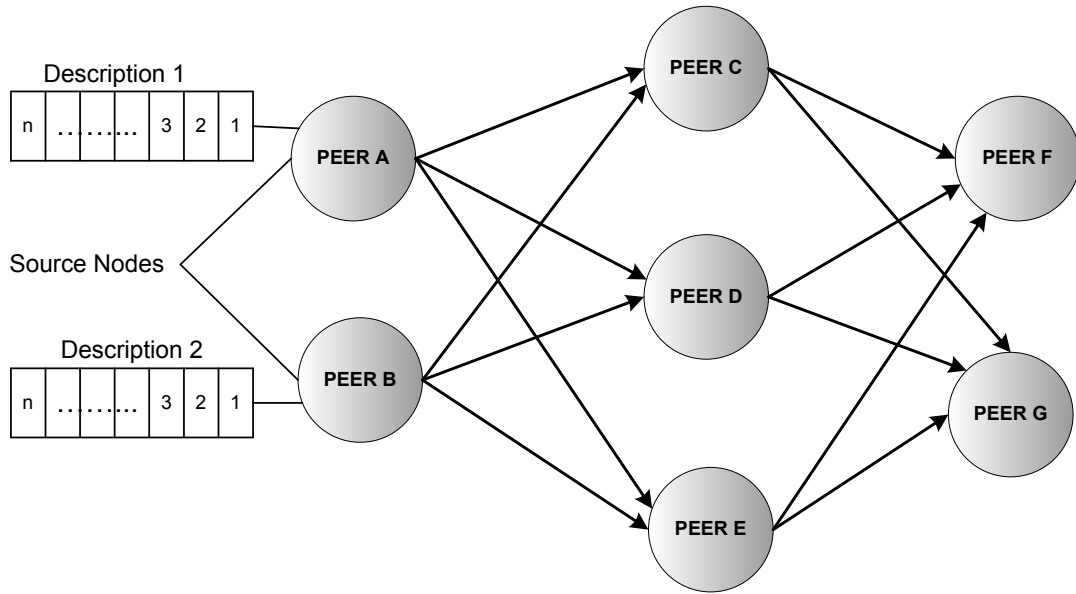

Figure 2. Mesh-based P2P topology sending MDC video streams from sources to receiver.

3. Multiple Description Coding

In general, MDC is difficult and computationally complex [11] because it requires synchronization between encoder and decoder to reduce motion estimation error drift. Unequal channel error protection is possible [26] and the coding rate can be adjusted according to the path characteristics and the likely distortion in the received video [27]. Various forms of splitting can occur including in the spatial domain [28] or frequency domain [29], but we consider temporal splitting in which a number of practical solutions have been proposed. In mobile devices with a limitation in battery power and/or processor computation power, simplicity is advisable.

In our scheme, two independent streams are formed from encoding odd and even frame sequences and sending over different paths. To create the effect of MDC, the skip frame(s) facility of the H.264 reference JM software (v. 14.2) was used. By insertion of intra-coded Instantaneous Decoder Refresh (IDR)-frames (spatially coded with no removal of temporal redundancy through motion compensation) either sequence can be resynchronized at the decoder, at a cost in increased data redundancy compared to sending a single stream with IDR-frames.

The H.264/AVC Main Profile was applied. This profile allows bi-predictive B-frames with greater coding efficiency than if only P-frames were to be employed. The GOP size was again 15 frames with the usual repeating pattern of two B- and one P-frame until the next I-frame. B-frames may be dropped with no impact on later frames. In the Main Profile, Context-Adaptive Binary Arithmetic Coding (CABAC) results in a 9-14% bit saving at a small cost in computational complexity [30].

Fig.3 illustrates an example of the frame compensation scheme tested for MDC. The frame numbers associated with each frame do not refer to a decoding sequence but to the original frame order as produced by the video camera. Suppose B_5 , P_7 and B_9 are lost then B_5 can be decoded from I_2 and P_8 of description 2. As it is a bi-predictive frame it requires at least two reference frames. P_7 can be decoded from I_2 as it is a predictive frame so it needs only one reference and similarly B_9

can be decoded from P_8 and P_{13} . In this case, closest frames will be selected for decoding to reduce the

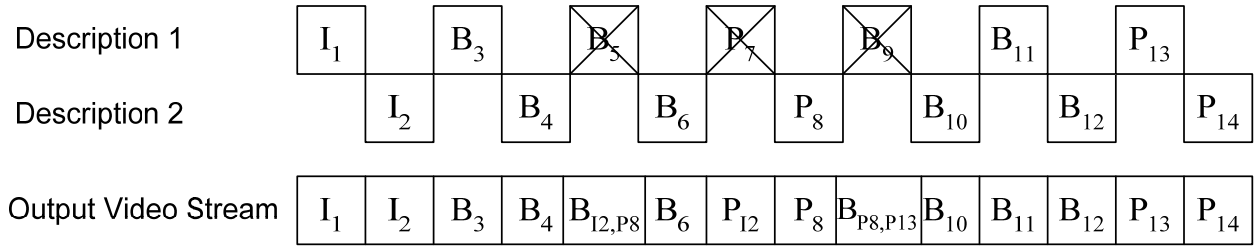

Figure 3. Example of frame compensation scheme for MDC after [10]

error. However if only one stream is used and suppose P_7 is lost then it would not be possible to decode all the frames following P_7 and this error (drifting error) will propagate until the next synchronization point i.e. intra-coded (I) frame is received, because an I-frame can be decoded independently. (An IDR and I-frame are equivalent in the H.264 codec.)

The well-known QCIF video clip Foreman was encoded for the tests. Foreman, intended for communication between mobile devices, exhibits the typical features of a hand-held camera and, because of scene motion and scene cuts, exhibits a higher coding complexity. The H.264/AVC Constant Bit Rate (CBR)-encoded data rates for description 1 and description 2 were 51.95 kbps and 51.93 kbps respectively. The frame rate of the video stream was set to be 15 fps.

4. Simulation environment

In order to identify the issues and limitation of P2P over MANETs we have extended the GloMoSim simulator [31] with P2P traffic sources mimicking a mesh architecture. The simulation time was set to be 500 s. GloMoSim was developed based on a layered approach similar to the OSI seven-layer network architecture. IP framing was employed with UDP transport, as TCP transport can introduce unbounded delay, which is not suitable for delay-intolerant video streaming. The well-known Ad-hoc On demand Distance Vector (AODV) [32] routing protocol was selected as it does not transmit periodic routing messages, which can result from proactive, table-driven protocols in greater control overhead unless network traffic is high. In reactive protocols such as AODV, routes are discovered only when they are actually needed in a hop-by-hop fashion rather than through source routing. Sequence numbers avoid routing loops. A disadvantage of a reactive protocol is the latency introduced by the route discovery process, which is judged in these simulations for its impact on video. At the data-link layer, CSMA/CA Medium Access Control (MAC) was set up to emulate an IEEE 802.11 wireless system.

The parameters for the simulations are summarized in Table 1. GloMoSim provides a two-ray channel model with antenna height hardwired at 1.5 m, and with a Friss free-space model with parameters (exponent, sigma) = (2.0, 0.0) for near line-of-sight and plane earth path loss (4.0, 0.0) for far line-of-sight. The radio range 250 m according to the 802.11 standard, with 2 Mbps shared maximum data-rate. Setting the bandwidth capacity to the latter value in the simulation allows modelling of a limited available bandwidth.

Table 1. Parameters for experiments

Parameter	Value
Wireless technology	IEEE 802.11
Channel model	Two-ray
Max. range	250 m
Roaming area	1000 × 1000 m ²
Pause time	5 s
No. of nodes	50 (10-100)
Min. speed	0 m/s
Max. speed	10m/s (1 – 35 m/s)
Mobility model	Random waypoint
Routing protocol	AODV

In our previous article [3], we tested three different terrain dimensions with the same number of nodes to see the effect of sparse (2000 × 2000 m²), average (1400 × 1400 m²) and dense (600 × 600 m²) node distributions. The results showed that a sparse distribution was prone to massive packet losses, while in the case of average node density the packet loss was too high. Only in the ‘dense’ condition was the packet loss acceptable for some configurations. Consequently, we choose 1000 × 1000 m² area for the simulations as a reasonable compromise. Choosing a ‘dense’ or a ‘sparse’ distribution would not give a realistic scenario.

The well-known random waypoint mobility model was employed with 50 nodes in a roaming area of 1000 × 1000 m². In this model, nodes are usually placed randomly in the simulated area. After pausing, the node moves to another random destination at a speed between a minimum and maximum speed. The pause time (time spent once a node reaches its destination) was set to 5 s. The minimum speed was 0 m/s, while the maximum node speed ranged from 1 to 35 m/s, i.e. from a slow walk to fast motorbike speeds.

Fig. 4 illustrates the steps followed to simulate MDC video streaming. In the first step, the raw video was split and encoded into even and odd frame sequences and then divided into packets from which a trace file was generated. This trace file formed the input to the GloMoSim simulation of the ad hoc network. Packet sizes and their sending times were recorded in a trace file. The video streams were sent as CBR streams with two sources sent over different paths to different receivers. After determining which frames were lost, the received frames from the two descriptions were merged and decoded separately with the JM H.264 software to generate the output video for display.

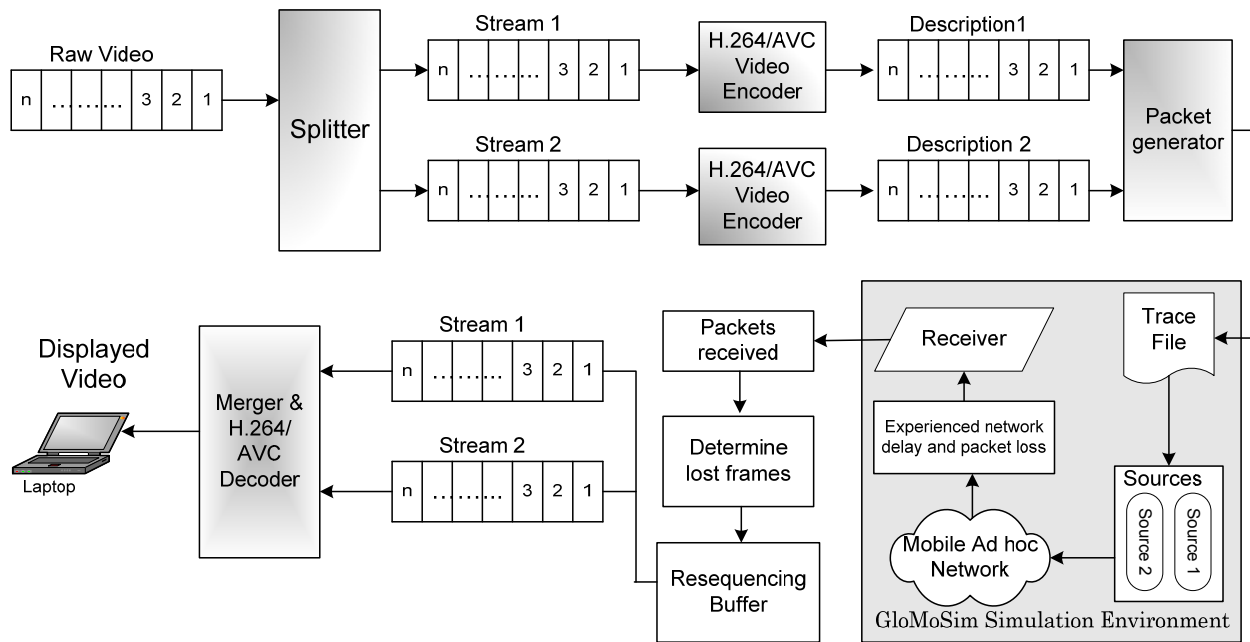

Fig. 4. H.264 and GloMoSim Simulation Environment for MDC, after [10]

Before assessing the performance issues of mesh P2P streaming with MDC over MANETs, it is necessary to identify the network parameters that could affect the Quality-of-Experience (QoE) of a streaming service. There is extensive literature on this subject and at Essex we also have carried out experiments [33]. Herein, we focus on three key parameters which can better reveal the impact of the video streaming techniques:

1. *Packet loss ratio*: The ratio between dropped and transmitted data packets. This gives an account of efficiency and the ability of the network to discover routes. Table 2 summarizes findings published in [33], correlating packet loss ratio with quality of experience. We note that QoE is extremely sensitive to packet loss, and, in the next Section, we will see that this is one of the major impediments to P2P streaming over MANETs.
2. *Average end-to-end delay*: The average time span between transmission and arrival of data packets. This metric includes all possible delays introduced by intermediate nodes for processing and querying of data. End-to-end delay has a detrimental effect on real-time video streaming. Its effect can be countered only to some extent by increasing buffering.
3. *Control overhead*: The routing overhead measures the protocol's internal efficiency. It is calculated as the total number of routing (control) packets transmitted divided by the number of data packets delivered successfully at destination. Herein, routing overhead is calculated in terms of packets.

For the video source described in Section 4, each frame was placed in a single packet, unless the packet was from an IDR-frame, in which case two packets were employed. An IDR-frame may occupy as much as 1 kB, whereas a B-frame will commonly be encoded in less than 100 B. This implies that though encoder CBR mode is selected, an encoder output is never completely CBR. For simple mesh-P2P each packet of size 300 B was sent every 60 ms to form a CBR stream.

Table 2. Quality-of-Experience acceptability thresholds [33]

Packet loss ratio [%]	QoE acceptability [%]	Video quality playback
0	84	Smooth
14	61	Brief interruptions
18	41	Frequent interruptions
25	31	Intolerable interruptions
31	0	Stream breaks

5. Simulation results

5.1 Scenario 1: (varying network size)

In this scenario, the numbers of nodes was varied from 10 to 100 nodes. Otherwise, the simulation parameters were as in Table 1. Fig. 5 shows the average packet loss ratio against number of nodes for mesh-P2P with and without MDC. Noticeably, packet loss decreases considerably in the high node density configuration because there will greater opportunities for packet transfer. In both cases, for a network size of more than 50 nodes the packet losses were within the acceptable range for P2P streaming, i.e. below 14% as per Table 2. The results of packet losses for separate receivers are shown in Table 3, where result shown for mesh-P2P with MDC is total loss in percentage terms after compensation between the two streams. These results show that in the case of mesh-P2P with MDC most of the receivers in many configurations were able to achieve the required QoE acceptability range as compared to simple mesh-P2P. In the case of MDC, one stream can compensate the losses from the other stream, which is not possible with simple mesh-P2P.

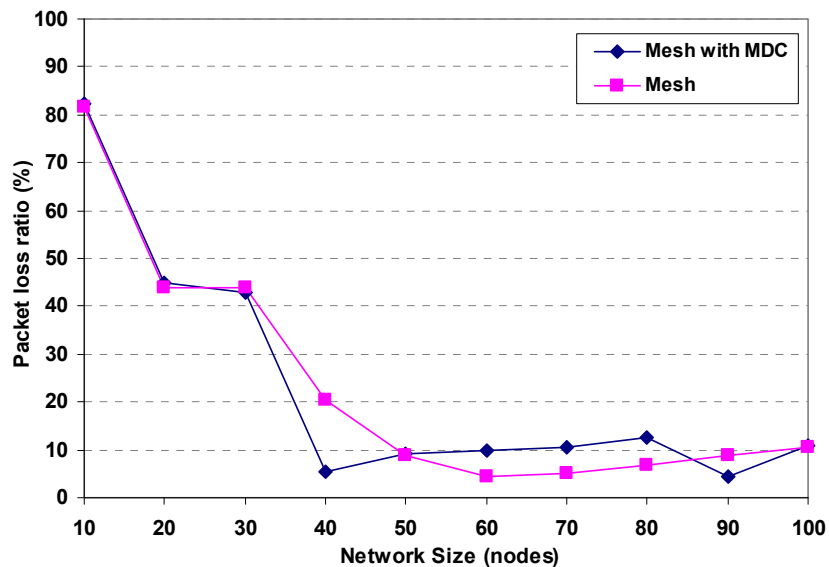

Figure 5. Packet loss ratio, varying node numbers.

Table 3. Packet loss rate (%) of receiver peers with simple mesh-P2P and mesh-P2P with MDC.

Packet loss rate (%) at receiver nodes										
Simple MESH P2P						MESH P2P with MDC				
Node	Peer C	Peer D	Peer E	Peer F	Peer G	Peer C	Peer D	Peer E	Peer F	Peer G
10	50	100	58	100	100	0	100	24	100	100
20	45	53	58	14	50	3	4	22	4	11
30	50	53	58	14	45	3	2	3	2	13
40	38	14	1	0	50	4	3	2	0	11
50	10	15	1	13	5	6	5	13	3	0
60	3	8	10	3	0	0	11	3	9	4
70	3	15	3	6	0	4	16	0	22	2
80	4	25	4	1	0	4	2	11	7	0
90	13	28	4	0	0	3	2	4	2	0
100	14	16	16	1	5	4	20	7	9	0
Speed										
1	10	5	4	10	0	4	0	0	4	4
5	6	3	0	0	0	0	0	4	18	0
10	10	15	1	13	5	6	5	13	3	0
15	0	25	0	4	0	12	0	4	0	2
20	3	21	16	4	23	8	19	5	2	0
25	14	14	25	4	23	4	11	6	3	18
30	20	6	11	10	0	0	18	27	5	0
35	24	20	26	6	5	3	26	0	0	16

Fig. 6 shows the average end-to-end delay incurred when altering the network size (the number of nodes). For both schemes, no clear trends are apparent in terms of number of nodes but at least 0.25 s of start-up delay occurs when streaming video one-way. Interactive video (two-way) streaming would incur unacceptable time lags in the response, especially if the video was accompanied by speech. If the playback buffer can absorb at least 0.2 s of video stream, then it would be enough to avoid frame loss. Turning to Fig. 7 again, there is no clear trend. However, the control overhead incurred by simple mesh-P2P is higher than mesh-P2P with MDC except for a network size of 100 nodes.

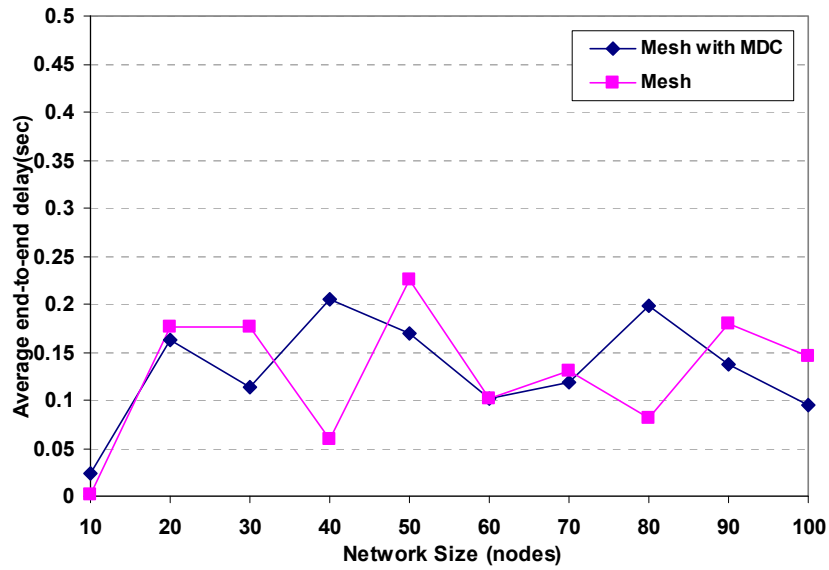

Figure 6. Average end-to-end delay, varying node numbers.

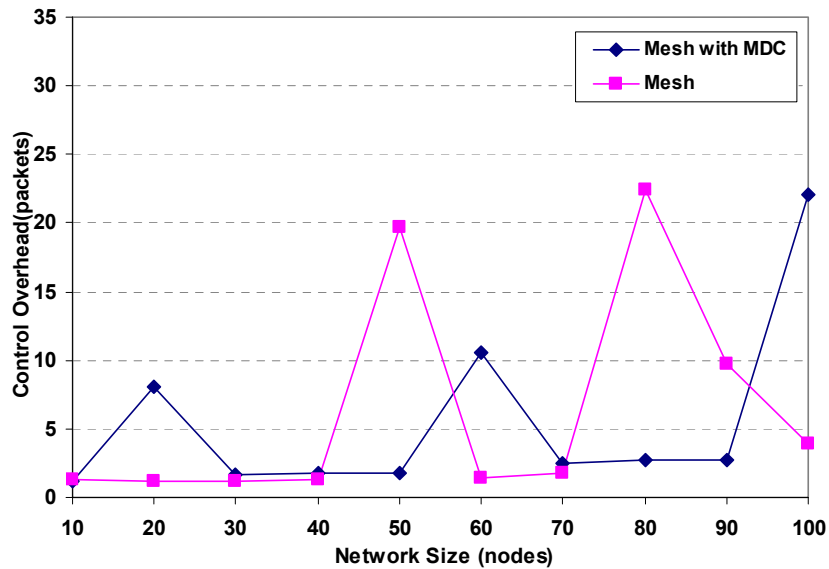

Figure 7. Control overhead, varying node numbers.

6.2 Scenario 2: (varying speed)

In this scenario, 50 nodes including seven sources were randomly distributed over a 1000×1000 m² area, settings were as in Table 1, except that speed varied from 1m/s to 35 m/s. Fig. 8 shows the packet loss incurred with varying speed. It is clear that packet loss increases with increase in speed. The results show 5% to 10% increase in packet loss at speeds higher than 15 m/s. Packet loss with speeds between 1-25 m/s are within acceptability bounds for the QoE range for both techniques. In Table 3, the packet losses for mesh-P2P with MDC are generally lower than those in simple mesh-P2P particularly in respect to changes in speed.

Fig. 9 shows the average end-to-end delay with varying speed. Average end-to-end delay is affected in the same way by altering speeds as by changing the network size. Delay across the network will result in a minimum of 0.25s start-up delay. However, delay incurred by simple mesh-P2P is higher than or equivalent to mesh-P2P with MDC at certain speeds. Fig. 10 illustrates the control overhead introduced by the two schemes. Control overhead incurred by simple mesh-P2P is higher at lower speeds and almost equivalent to mesh-P2P with MDC except that a peak is observed at 30m/s.

In Fig. 11 the resulting video quality is calculated for a sample receiver, i.e. Peer E with the different packet loss ratios recorded in Table 3. An objective measure of the delivered video quality, Peak Signal to Noise Ratio (PSNR)², is reported. This is because network statistics can be misleading. For example, if the packets that are lost are from reference frames, then the impact is greater than indicated by loss statistics alone. Conversely, if packets are lost from bi-predicted B-pictures then the loss will not impact upon later frames and will be barely noticed by the viewer, especially if error concealment allows the missing data to be reconstructed. In Fig. 11, though a quality greater than 25 dB is advisable, users will generally accept levels between 20-25 dB in mobile wireless scenarios [34]. From the Figure such levels are achieved with packet loss rates as high as 15%. Were it not for the presence of MDC, then packet losses above 5% are likely to lead to poor quality video.

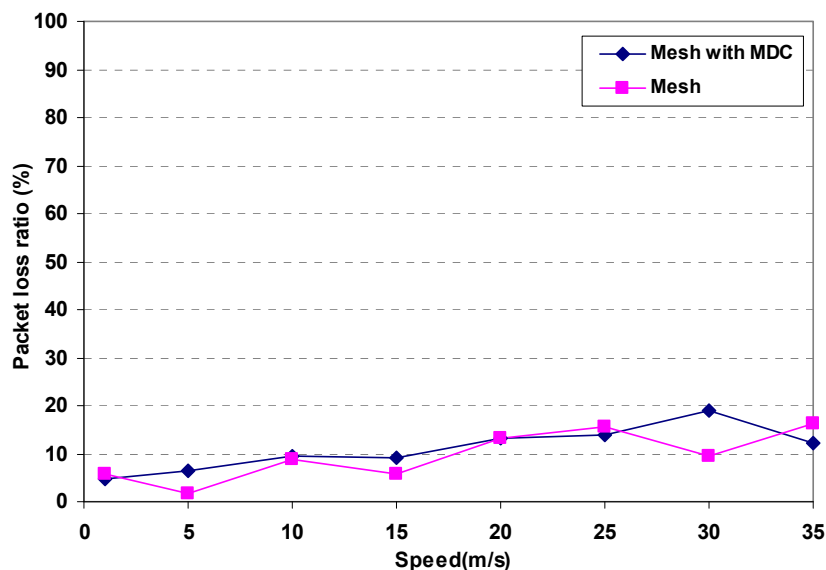

Figure 8. Packet loss ratio with variation in speed.

² PSNR = 10 log (MAX²/MSE), where MAX is the maximum intensity value possible for a pixel, and ME is the pixel-wise mean square error between a reference frame and the frame under test.

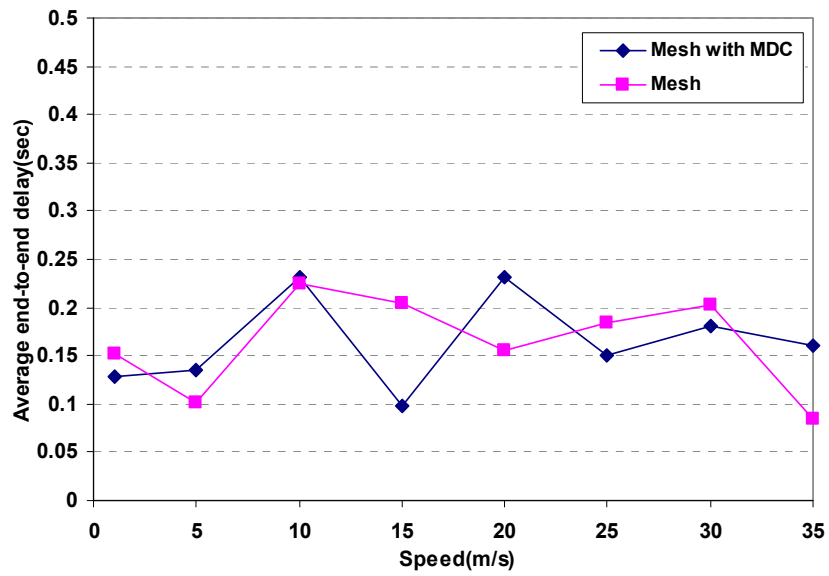

Figure 9. Average end-to-end delay with variation in speed.

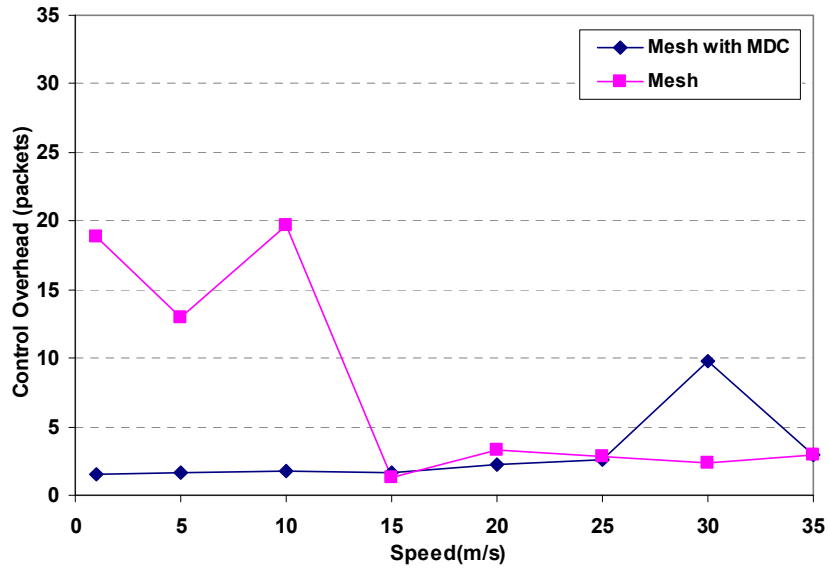

Figure 10. Control overhead with variation in speed.

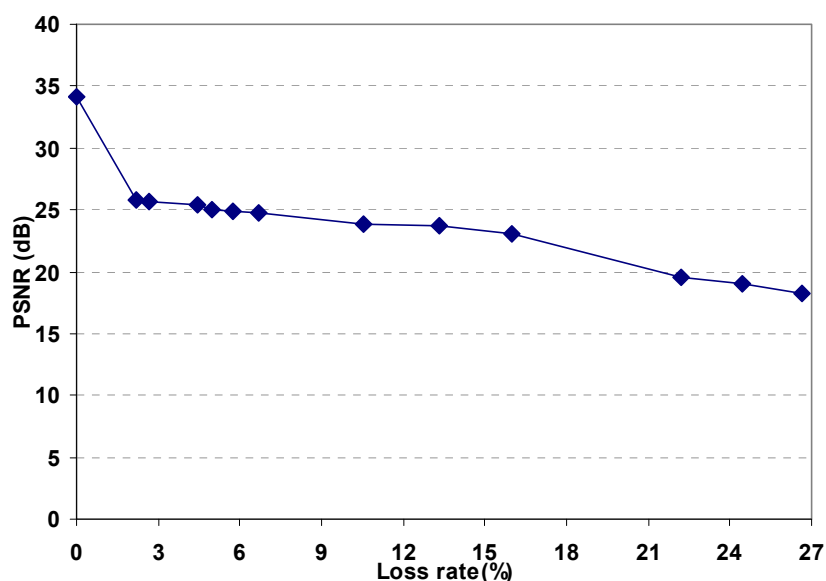

Figure 11. Video quality for MDC by packet loss ratio.

6. Conclusions

There appears to be a synergy between P2P networks and MANETs, as both can function together to enhance the capabilities of each paradigm. P2P file download has been extended on fixed, wired networks, principally the Internet, to multimedia streaming, chiefly video because of the higher bandwidths involved. This paper has established that if video chunks or blocks are distributed to two or more peers within a MANET, than Multiple Description Coding is a way of streaming the same portion of video from any two of the peers in such a way that the quality is at an acceptable level despite significant packet loss rates. Though end-to-end delay can be absorbed by suitable buffering, multi-hop routing does result in higher levels of delay than would be experienced on a fixed network and these levels mean that interactive P2P streaming is not possible. In fact, investigation of ways to allow streaming between physically close nodes within the MANET will reduce latency and are the subject of our future investigations.

Acknowledgment

We are grateful to Mr. Majed Alhaisoni for his suggestion prior to this work on initial experiments for P2P streaming.

References

- [1] J. Wu (ed.), *Handbook on theoretical and algorithmic aspects of sensor, ad hoc wireless, and peer-to-peer networks*, Auerbach Pubs., Boca Raton, FL, 2006.
- [2] L. Yan, "Can P2P benefit from MANET? Performance evaluation from users' perspective," *Int. Conf. on Mobile Sensor Networks*, pp. 1026-1035, 2005.
- [3] N. N. Qadri, M. Alhaisoni, and A. Liotta, "Mesh based P2P streaming over MANETs," *6th ACM Int. Conf. on Advances in Mobile Computing & Multimedia*, Linz, Austria, Nov. 2008.
- [4] C. S. R. Murthy and B. S. Manoj, *Ad hoc wireless networks, architecture and protocols*: Prentice Hall, Upper Saddle River, NJ, 2004.

- [5] L. Yong, Y. Guo, and C. Liang, "A survey on peer-to-peer video streaming systems," *Peer-to-Peer Networking and Applications*, vol. 1, pp. 18-28, 2008.
- [6] L. B. Oliveira, I. G. Siqueira, and A. A.F. Loureiro, "On the performance of ad hoc routing protocols under a peer-to-peer application," *Journal of Parallel and Distributed Computing*, vol. 65, no. 11, pp. 1337 - 1347, 2005.
- [7] M.-P. Ketan, "Systems challenges of media collectives supporting media collectives with adaptive MDC," *15th Int. Conf. on Multimedia*, pp. 625-630, Augsburg, Germany, 2007.
- [8] L. Zhengye, Y. Shen, S. S. Panwar, K. W. Ross, and Y. Wang, "P2P video live streaming with MDC: Providing incentives for redistribution," *IEEE Int. Conf. on Multimedia and Expo*, pp. 48-51, Beijing, China, July 2007.
- [9] M.-F. Leung, S.-H. Chan, and O. Au, "COSMOS: Peer-to-peer collaborative streaming among mobiles," *IEEE Int. Conf. on Multimedia and Expo*, pp. 865-868, Toronto, Canada, July 2006.
- [10] C.-O. Chow and H. Ishii, "Enhancing real-time video streaming over mobile ad hoc networks using multipoint-to-point communication," *Computer Communications*, vol. 30, pp. 1754-1764, 2007.
- [11] Y. Wang, A. R. Reibman, and S. Lin, "Multiple description coding for video delivery," *Proc. of the IEEE*, vol. 93, no. 1, pp. 59-70, 2005.
- [12] J. Chen, S.-H. G. Chan, and V. O. K. Li, "Multipath routing for video delivery over bandwidth-limited networks," *IEEE Journal on Selected Areas in Communications*, vol. 22, no. 10, pp. 1920-1932, 2004.
- [13] J. Karlsson, H. Li, and J. Eriksson, "Real-time video over wireless ad-hoc networks," *14th Int. Conf. on Computer Communications and Networks*, pp. 596-607, Oct. 2005.
- [14] M. Ghanbari, "Standard codecs: Image compression to advanced video coding" , IET Press, Stevenage, UK 2003.
- [15] E. Gürses, and A. N. Kim, "Maximum utility peer selection for P2P streaming in wireless ad hoc networks," *IEEE GLOBECOM*, pp. 1-5, New Orleans, FO, Nov. 2008.
- [16] D.-H. Zuo, X. Du, and Z.-K. Yang, "Hybrid search algorithm for P2P media streaming distribution in ad hoc networks," *Int. Conf. on Computer Science*, pp. 873-876, May 2007.
- [17] Y.-S. Liu, Y.-M. Nuang, and M.-Y. Hsieh, "Adaptive P2P cahcing for video broadcasting" , *Joint Conf. on Information Sciences*, 2006.
- [18] E. Giordano, A. Ghosh, G. Pau, and M. Gerla, "Experimental evaluation of peer-to-peer applications in vehicular ad-hoc networks", *First Annual International Symposium on Vehicular Computing Systems*, Dublin, Ireland, July 2008.
- [19] X. Hei, C. Liang, J. Liang, Y. Liu, and K. W. Ross, "A measurement study of a large-scale P2P IPTV system," *IEEE Transactions on Multimedia*, vol. 9, no. 8, pp. 1672-1687, 2007.
- [20] Y. Liu, Y. Guo, and C. Liang, "A survey on peer-to-peer video streaming systems," *The Journal of P2P Networking and Applications*, vol. 1, no. 1, pp. 18-28, 2008.
- [21] X. Fu, J. Lei, and L. Shi, "An experimental analysis of Joost peer-to-peer VoD service," Technical Report, Institute of Computer Science, University of Göttingen, Goettingen, Germany 2007.
- [22] X. Zhang, J. Liu, B. Li, and Y.-S. P. Yum, "CoolStreaming/DONet: a data-driven overlay network for peer-to-peer live media streaming," *IEEE INFOCOM*, pp. 2102-2111, March 2005.
- [23] R. Reza, "Anyone can broadcast video over the Internet," *Commun. ACM*, vol. 49, pp. 55-57, 2006.
- [24] P. Shah, J.-F. Paris, "Peer-to-peer multimedia streaming using Bit-Torrent," *IEEE Int. Performance Computing and Communication Conf.*, pp. 340-347, April 2007.

- [25] D. Jurca, J. Chakareski, J. Wagner, and P. Frossard, "Enabling Adaptive Video Streaming in P2P Systems," *IEEE Communications*, vol. 45, no. 6, pp. 108-114, 2007.
- [26] R. Puri and K. Ramchandran, "Multiple description source coding using forward error correction codes," *33rd Asilomar Conf. on Signals, Systems, and Computers*, pp. 342-346, Pacific Grove, CA, USA, Feb. 1999
- [27] Y. J. Liang, E. Setton, and B. Girod, "Channel-adaptive video streaming using packet path diversity and rate-distortion optimized reference picture selection," *IEEE Workshop on Multimedia Signal Processing*, pp. 420- 423, Oct. 2002.
- [28] N. Franchi, M. Fumagalli, R. Lancini, and S. Tubaro, "Multiple description video coding for scalable and robust transmission over IP", *IEEE Trans. on Circuits and Systems for Video Technology*, vol. 15, pp. 321- 334, 2005.
- [29] A. Reibman, H. Jafarkhani, Y. Wang, and M. Orchard, "Multiple description video using rate-distortion splitting," *IEEE Int. Conf. on Image Processing*, pp. 971-981, Oct. 2001.
- [30] D. Marpe, H. Schwarz, and T. Wiegand, "Context-based adaptive binary arithmetic coding in the H.264/AVC video compression standard," *IEEE Transactions on Circuits and Systems for Video Technology*, vol. 13, pp. 620- 636, 2003.
- [31] X. Zeng, R. Bagrodia, and M. Gerla, "GloMoSim: A library for parallel simulation of large-scale wireless networks, " *Workshop on Parallel and Distributed Simulation*, pp. 154-161, May 1998.
- [32] C. E. Perkins, E. M. Royer, and S. R. Das, "Ad Hoc on Demand Distance Vector (AODV) Routing," RFC 3561, July 2003.
- [33] F. Agboma, M. Smy, and A. Liotta, "QoE analysis of a peer-to-peer television system," *IADIS Int. Conf. on Telecommunications, Networks and Systems*, Amsterdam, Netherlands, 2008.
- [34] A. H. Sadka, *Compressed video communications*, J. Wiley and Sons, Chichester, UK. 2002.